



TUNA
CORPORATION



ZHEJIANG TUNA ENVIRONMENTAL SCIENCE&TECHNOLOGY CO.,LTD

Add: Paojiang Industrial Park, Shaoxing City, Zhejiang Province, China. 312000

Tel: +86-575-88556000 Fax: +86-575-88556056

Email: overseas@zj-tuna.com

www.zj-tuna.com Hotline:400-7116-117

Professional Flue Gas Treatment Solutions For Ultra-Low Emission Control

PRODUCT

Catalog

ABOUT TUNA

Zhejiang TUNA Environmental Science & Technology Co., Ltd. (stock code: 603177) is a national key high-tech enterprise specializes in flue gas treatment industry. TUNA has become an integrated service enterprise that covers desulfurization(FGD), denitration(DeNO_x), high-efficiency dust removal and other flue gas treatment integrating R & D, engineering, and manufacturing, providing service for power, metallurgical and petrochemical industries etc. The products have been installed in more than 1,000 projects, clients including China Top 5 power generation groups Huaneng, Guodian, Huadian, Datang State Power Investment Corporation, Baosteel, Sinopec and so on. In addition, the FGD equipments and SCR catalyst have been exported to many countries, such as USA, Poland, Italy, Korea, Turkey, Russia, India, Malaysia, Vietnam, Philippines, Indonesia, and so on.

We are expanding our business into global market with our rich experiences in China, and participating on global emission control projects to make the world a better place to live in.

04-25	FGD Products
26-39	SCR Catalyst
40-45	ESP & GGH
46-51	Electric Products
52-57	Project References





Product range



1. Damper:

Single-shaft and double louver doors, single-shaft and single louver door.



2. Mist Eliminator:

Chevron type, plate type, duct (vertical) type, pipe type.



3. Ball Mill:

Ball mill (dry ball mill, coal-water slurry mill and auxiliary system).



4. Dehydrator:

Vacuum belt dehydrator, disc vacuum filter.



5. Slurry Pipe:

FRP spray pipe, double-side rubber-lined main spray pipe.



6. Rubber-lined pipe:

Rubber-lined pipe, double-side rubber-lined main pipe.



7. Non-standard accessories:

Filter gauze, oxidation air pipe (FRP, PP, alloy).



Still Expanding.....

Single-shaft double louver series damper: safe and reliable, zero leakage, all-round anti-corrosion and easy maintenance.

Features

- ① **Reliability:** Calculate strength and deformation in finite element method to guarantee reasonable structure.

- ② **Advanced hermetically-sealed construction:** Sealing material is C-276 after special treatment of good elasticity. When the damper is closed, the sealing strips contact in sealed way. The seal clearance is small. With the patented technology (self-reinforced seal structure), the long-term seal effect of the equipment can be effectively guaranteed.

- ③ **Perfect anti-corrosion design:** Anti-corrosive surface avoids osmosis of carbon steel during welding; strict welding process guarantees anti-corrosion performance.

- ④ **Assisted fast opening design of bypass:** Assisted fast opening function is of patent design, which reduces starting torque for actuator and enhances security and reliability.

- ⑤ Positioning chain for switches of **safety precautions** to guarantee the safe operation and prevent misoperation.

- ⑥ **Less resistance:** Damper is without central frame to reduce resistance and leakage.

- ⑦ **Easy installation:** Add intermediate support to ultra wide door, adopt malposition design for gate flaps on both sides to avoid bearing seizure and make maintenance easier.

- ⑧ Electric heater adopts automatic stepless adjustment to **save energy** and prolong lifespan.

- ⑨ Adjustable connecting rod to guarantee **accurate position** and flexible rotation.



Damper Accessories



Sealing filler: The sealing filler is made of Teflon material, used for sealing of the shaft end of the damper vane to prevent leakage. Such filler is corrosion-resistant and wearproof, is self-lubricated, and has small friction coefficient and fine sealing effect.



Sealing strip: The structure of the sealing strip adopts TUNA's patent technology. With special treatment, the alloy-steel sealing strip has very fine mechanical strength, fine elasticity and is corrosion-resistant. With the self-reinforced structure, the long-term sealing effect of the equipment can be effectively guaranteed. Size is customizable.



Bearing with pedestal: High-quality external spherical self-aligning ball bearing with square pedestal, and it is used for the driving shaft of the damper vane. Self-aligning within a certain angle range. The bearing rotates flexibly, has long service life and is convenient for replacement and maintenance.



Joint bearing: High-quality steel universal ball end joint bearing. The automatic self-aligning range is $\pm 17^\circ$. The bearing rotates flexibly, has high mechanical strength. Convenient for replacement and maintenance.



Limit switch: Imported OMRON limit switch; service life >300,000 times. Operates stably, with adjustable length and direction of its swing link.

PTFE sliding bearing: Made of Teflon, and is used for the driven shaft of the damper. Compact structure, small friction coefficient, high wear-resistance and anti-fatigue strength, fine corrosion-resistance, with self-lubrication, sound absorption, vibration damping and so on. Generally, the bearing is used together with the external spherical self-aligning ball bearing with square pedestal.

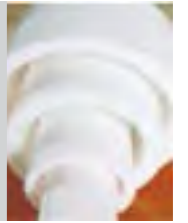

Actuator: The actuator is provided with torque protection and position limiting measures, remote controlled. Manual operation is provided for adjustment in installation and overhaul purposes.

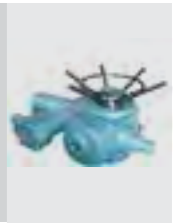

Seal fan and accessories: Including the motor, mounting base, outlet square to round joint, expansion joint.



Butterfly valve: Zero-leakage, prevent backflow of the flue gas and protect the seal pipe system from corrosion.



Heater: Including electric heater and steam heater.



Product description

Advanced technology and process, customized design TME type mist eliminator. Plate-type and chevron-type mist eliminator for vertical gas-liquid separation, and horizontal type mist eliminator for horizontal ducting gas-liquid separation. Long-period stable operation, rational structure, achieve full separation of gas and liquid and flushing effect.

Features

- ① New model: the third generation vane structure can remove particles of 5-20 micrometer.
- ② High efficiency: dust emission $\leq 10 \text{ mg/Nm}^3$, droplet emission $\leq 20 \text{ mg/Nm}^3$.
- ③ Modular design: short period of installation, easy maintenance.
- ④ Small volume: by adding layers inside the absorber or adding the demister.
- ⑤ Reduce water consumption by 10%.

Material characteristics

TME type mist eliminator module is made by polymer that has high strength and fine corrosion resistance. Thus, TME type mist eliminator has excellent chemical and physical performance.



Flushing nozzle
Clipping strip pipe clip

Flushing system

Flat plate type module

Chevron type module



Mist Eliminator Accessories

No.	Item	Application
1	Flushing nozzle	Used for flushing the Mist Eliminator, 90°/120° solid taper
	Clipping strip	Used for vane positioning
	Pipe clip	Used for fixing the pipe of flush system
2	Flushing system	Used for flushing the Mist Eliminator
3	Vane module	A part of the Mist Eliminator



Parameter List of Ball Mill

Specification	Effective volume (m ³)	Actual speed (r/min)	Power (kW)	Throughput (t/h)
MST2150	15.1	23.2	≤200	5
MST2254	18.0	21.8	≤280	7
MST2458	23.2	21.2	≤380	10
MST2560	25.4	20.8	≤400	12
MST2760	30.4	20.8	≤450	14
MST2765	32.9	20.8	≤500	16
MST2965	38.3	19.3	≤630	18
MST2970	41.3	19.3	≤630	20
MST3264	46.5	18.7	≤710	23
MST3270	50.8	18.7	≤800	25
MST3280	58.4	18.7	≤1000	29
MST3480	66.4	17.5	≤1120	34
MST3485	70.1	17.5	≤1120	36
MST3680	74.4	17.2	≤1250	38
MST3685	78.96	17.2	≤1250	40

Remark:The output is estimated based on feed size ≤20mm, overflow wt%=30%, throughput rate of 325 mesh is 90%, erosive index is 11kw.h/t.



Ball Mill Accessories



Elastic pin gear coupling: The pin is made of several non-metal materials, and is placed at the alignment hole between the two half couplings and the internal surface of the outside ring. The torque is transmitted via the pin to realize connection of the two half couplings.



Feed pipe and feed housing: The feed pipe is made of wearproof steel. The feed housing is made of carbon steel lined with rubber in order to increase the equipment service life and effectively prevent leakage at the feeding part.



Wearproof rubber lining plate: Fairly higher strength, excellent wear resistance and high elasticity. Reduce mechanical shock, low noise, long service life.

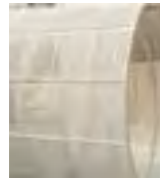

Discharging sieve: Made of 1Cr18Ni9Ti material to guarantee long service life.



Main shaft bushing: The shaft bush is made of tin-based or lead-based babbitt metal. On the soft-phase matrix, the hard-phase particles are distributed uniformly. The very small clearance is formed between the sliding surfaces to provide the passage of the lubricating oil, and friction is reduced; the hard particle has supporting effect, and is good for bearing.



Bull gear and pinion: The bull gear is 310-570 treated, with surface hardness of the gear top circle not less than HB180. The pinion is made of 35SiMn undergoing quenching and tempering. After treatment, the surface hardness of the gear top circle not less than HB200.



Valves and instruments: Both imported and domestic rubber-lined butterfly valves are available, regulating valves, mass flowmeters, densitometers and other instruments of different specifications.

Injector and accessories: Via the inject nozzle, the lubricant is sprayed to the loaded tooth surface of the pinion (driving wheel). When the pinion engages with the bull gear, the lubricant will be carried to each engagement plane.

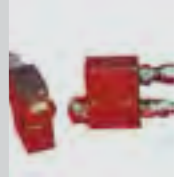

Discharging spiral pipe: The pipe is made of Q345 wearproof steel in order to increase the equipment service life. With the design of double spiral pipes, it is good for steel ball and large-size lime stone to return to the barrel of the ball mill in time.



Taper type feed hopper: Carbon steel lined with rubber, increasing the equipment service life.



Steel ball: The ball is ZQCr12 or ZQCr17 high-chrome ball, the surface as-quenched hardness is >HRC56.



Bearing and bearing pedestal: Both imported and domestic bearings and bearing pedestals of different specifications and models can be provided.



Hydro-cyclone: Imported cyclones.



Agitator: High-efficiency agitator of various specifications are available.



Product description

TUNA self-developed TBF-DU-type rubber belt vacuum dehydrator is of high efficiency, good scrubbing effect, complete filtration regeneration, good controlling force and easy maintenance.



Features

- ① Adopt modularized design for framework, vacuum box and belt support, which is easy for installation and replacement.
- ② Special rubber belt with skirt or skirt with steel combination: free of cloth layer at center hole to avoid corrosion and damage to the cloth skirt.
- ③ The cloth has excellent filtration uniformity, mechanical strength and corrosion resistance.
- ④ Vacuum box is made of FRPP or stainless steel, which is of good corrosion resistance and of smooth inner wall.
- ⑤ The rubber belt is supported by roller: stable operation, small abrasion, long service life.
- ⑥ Adoption of air bag or cylinder automatic on-line rectification to ensure the stable operation of the filter cloth.
- ⑦ The speed of the belt is automatically adjusted according to the feeding amount, and a fault alarm device is used to make sure that the system is always working under good condition.
- ⑧ Liquid level of tank for filter cake and filter cloth washing can be automatically controlled, therefore automatic watering and disemboque can be finished by itself.
- ⑨ Cloth is automatically tightened by gravity.

Product description

High filtration efficiency, energy saving, small occupied area, stable operation and maintenance, etc.



Features

- ① Take elevation as filtering surface instead of horizontal plane, effectively reduce occupation of land.
- ② Adoption of high-tech filter medium to separate the slurry. The filtrate is clear, transparent, recyclable, and basically free of particles.
- ③ Small vacuum loss, low energy consumption, save energy consumption by 70%. Save fresh water by 20%.
- ④ Rational and compact structure, stable and reliable operation and low-cost maintenance.
- ⑤ Suitable for coal-fired plants with high sulfur content while facing the problem of land shortage.

Dehydrator Accessories



Rubber filtering belt / Vacuum belt: It is also called vacuum belt, and is the key and supporting part of the horizontal rubber belt type vacuum filter (vacuum belt dehydrator). The skeleton is made of polyester canvas or Dacron cloth with excellent performances, and has such characteristics as high strength, acid/alkali resistance, heat resistance, oil resistance, cold resistance and so on.



Skirt edge: The rubber belt skirt edge uses the combined structure, the wave form skirt edge is bonded to the parallel rubber belt. Such structure has fine elasticity, and can prevent breakage caused by direction change while the skirt edge passes the drum, and can effectively prevent material pulp leakage and is convenient for replacement.



Friction band: The friction band is mounted between the vacuum box and rubber belt, is sealed, lubricated and cooled with water and is used for reducing the resistance during rubber belt operation. Material: Rubber + nylon substrate + reinforced nylon wire. Specification: It can be fabricated based on the length required by the equipment, the thickness includes 6.5mm, 7mm, 8mm and 10mm.



Filter cloth and filter cloth repair kit (line, glue): The imported and domestic filter cloths of different specifications and models can be provided by the Company. The materials include polyester and polypropylene. Specification: Width: within 3.5m, length: no limit.

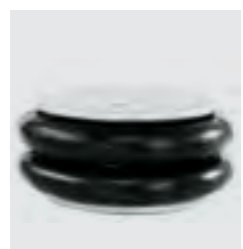

Air cylinder and air bag: Used for correcting the deviation of the filter cloth. The imported and domestic air bags and air cylinders of different specifications and models can be provided. Besides, the air bags and air cylinders can be customized based on customers' requirements.

Bearing and bearing pedestal: Imported and domestic bearings and bearing pedestals of different specifications and models can be provided by the company.



Suction hose: The hose is used for connecting the vacuum box and the vacuum main pipe. PVC steel wire is used for reinforcing the hose material.



Gypsum scarper plate and roller: Scraper and roller.



Coupling: Used for shaft driving.



Sliding table: The sliding table is a key position to ensure the stable operation of the belt dehydrator. The friction band is mounted at the groove of the sliding table and is sealed with water. The sealing water can not only be used as the lubricant of the sealing device, but also can be used as the coolant to form a greatly effective vacuum seal.



Rubber roller: The rubber wrapping the drum is butyronitrile rubber material. The company can produce rubber rollers of different specifications, and can customize the rollers based on the clients' requirements. The rollers have such characteristics as high precision, wear resistance, shock resistance, anti-corrosion and so on.



Spray nozzle: Various imported and domestic spray nozzles of different specifications and models can be provided by the Company, and such nozzles are used for flushing the filter cloth and rubber belt.



Dehydrator Accessories



Instrument: Frequency converter, pressure transmitter, thickness gauge, limit switch, flow switch, liquid-level switch, pull switch and so on. Used for controlling the vacuum belt dehydrator. Imported and domestic instruments of different specifications and models can be provided by the Company, and technical support for type selection can also be provided.



Valve: Including such valves as ball valve, butterfly valve, floating valve and so on.



Filter cloth deviation correcting valve: Used for correcting the deviation of the filter cloth.

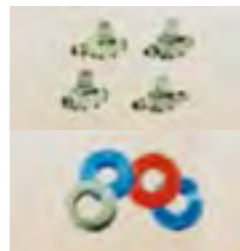

Pu pipe and joint



V belt: Used for belt driving, such as vacuum pump, pulp blender and so on.



Vacuum box: The vacuum box is used for collecting the filtrate of liquid discharging tape bottom surface. Its center line coincides with the center lines of the liquid discharging belt and the central discharging hole. The section of the vacuum box presents O shape. When the vacuum belt dehydrator runs, the vacuum box is fixed. Material: FRPP, 304, 316L, carbon steel lined with plastic.



Filter cloth deviation correcting device: For the filter cloth deviation correcting device, the air bag is used for pushing the one side of the deviation correcting roller to sway by certain angle to correct the deviation of the filter cloth. The air bag and control elements are imported products, and have stable and reliable quality.

Vacuum pump: Used for evacuation of the vacuum belt dehydrator system.



Pump: Used for flushing the filter cloth and the filter cake of the vacuum belt dehydrator.



Gas-liquid separator: It is used for gas-liquid separation of the dehydrator, is made of carbon steel lined with rubber or PPR. In addition, there is alarm switch for high liquid level to realize automatic protection for the vacuum belt dehydrator.



Flush water tank: The filter cloth flush water tank is made of carbon steel lined with rubber. The liquid outlet of the steam-water separator of the vacuum pump is connected to the water inlet of the filter cloth flush water tank. The water make-up valve is floating valve, with automatically make up of service water. Alarm switch for low liquid level for automatic protection to the filter cloth flush water pump.

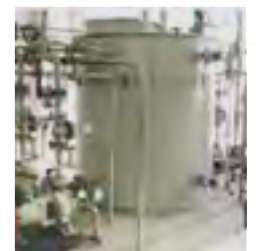

Metering pump: Conveying the dilute nitric acid.



Distribution board: Distributing the vacuum pipeline and flushing water pipe.



Filter plate: It is a new type filtering medium, and is used as the core accessory of the vacuum round disc dehydrator.



Scraper: It can make the filter cake to leave the filter plate.



Product description

TUNA's FGD slurry pipe is made of TSP composite material with FRP polymer based composite as main material. The manufacturing procedure includes mixing, mold filling, drying and molding. The product is of light weight, high strength, strong corrosion resistance, good abrasive resistance, good system reliability and long lifespan.

The manufacturing procedure adopts once forming technology for complex part such as triplet, which greatly strengthens the mechanism strength; the smooth internal surface reduces surface frictional resistance coefficient, prolongs its lifespan, reduce resistance for pump head, therefore greatly saving the cost; the addition of wear-resisting agent on the internal and external surface improves its mechanism strength and abrasive resistance.

Features

- ① Good corrosion resistance and abrasive resistance, with high-strength, anti-corrosive anti-frictional resin as base material.
- ② Light weight and high strength.
- ③ Low permeability.
- ④ Good fabricability.
- ⑤ Smooth inwall to reduce pressure resistance and increase flow rate.
- ⑥ Low cost and maintenance cost.
- ⑦ Long lifespan.
- ⑧ Easy installation.



Slurry Piping Accessories

No.	Item	Application
1	Spray nozzle	Single/double tangent type solid /hollow cone, spiral type
2	Nozzle dredge	Field instruction for nozzle dredge
3	Replacement and repair of branch pipe	Service for professional repair and replacement of fractured or blocked branch pipes
4	Epoxy resin	Indigenous /imported epoxy resin



Spray nozzle: Provide the single/double tangent type solid /hollow cone / spiral imported/domestic spray nozzles.



Nozzle dredge: The professional engineering personnel can provide site guidance for dredging the spray nozzle.



Replacement and repair of branch pipe: Professional repair and replacement services for scale formation or rupture of the branch pipe.



Vinyl resin: High-quality vinyl resin.

Product description

Rubber-lined pipes is widely applied to chemical, power, papermaking, pharmacy and environmental protection industries.

TUNA has the capacity of fabricating pipes, slab rubber production, rubber lining and site installation. Customizable rubber slab and construction technology, such as self-vulcanization, prevulcanization, heat vulcanization.

Features

- ① High strength of steel base structure.
- ② Excellent anti-corrosion performance.
- ③ Excellent abrasive resistance.
- ④ Excellent aging resistance.
- ⑤ Easy and quick installation and maintenance.

Main technical index of rubber slab

Index	Unit	Butyl rubber	Chloride rubber	Soft quality	Hard quality	Butylbenzene	Nitrile rubber
Shore hardness	A	50~70	55~55	40~80	65~85	50~70	85
Tensile strength	MPa	≥6	≥8	≥9	≥15	≥8	18
Elongation rate	%	≥350	≥350	≥250		≥350	≥300
Tensile deformation	%	≤35	≤30	≤40	≤20	≤20	≤20
Maximum operation temperature	°C	-60~130	-30~120	-60~90	-60~100	-30~120	-30~120
Acid fastness		Excellent	Good	Good	Good	Good	Good
Alkali resistance		Excellent	Good	Good	Good	Good	Good
Water resistance		Excellent	Excellent	Excellent	Excellent	Excellent	Excellent
Abrasion		Excellent	Excellentw	Excellent	Excellent	Excellent	Excellent

Rubber-lined Pipes Accessories

No.	Name	Application
1	Prevulcanized / vulcanized rubber	For repairing Rubber-lined pipes
2	Rubber-lined steel parts	Rubber lining provided for welded steel parts.
3	Rubber-lined pipes	For transportation of limestone, gyp sum slurry
4	Rubber-lined pipe fittings	For transportation of limestone, gyp sum slurry



SCR Catalyst

TUNA is the first Chinese catalyst manufacturer who has both honeycomb-type and plate-type catalyst with an annual production capacity of 38,000m³, which honeycomb-type catalyst represents 18,000m³ and plate-type catalyst represents 20,000m³. TUNA also owns independent R&D technology of catalyst regeneration. TUNA's catalyst has been widely applied to the Top-5 power groups (Huaneng, Huadian, Guodian, SPIC and Datang), local power plants with more than 200 large and medium size flue gas denitration projects.

Product Range

- ① Honeycomb type catalyst (16~60 cell)
- ② Plate type catalyst
- ③ Wide-temperature catalyst
- ④ Dioxins catalyst
- ⑤ Catalyst regeneration



SCR Catalyst



Power



Marine



Chemical industry



Waste incineration



Glass



Steel

SCR reaction principle

As for the selective catalytic reduction (SCR) technology, with the reducing agent (such as NH₃), at the proper temperature and with existence of catalyst, nitrogen oxides (NO_x) is converted to be nitrogen and water that naturally exist in the air, and the denitration efficiency can reach more than 90%. With its maturity and high denitration efficiency, SCR denitration technology has become the mainstream technology for flue gas denitration in the world.

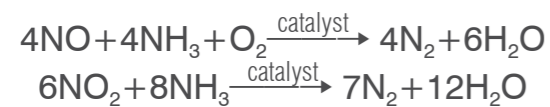
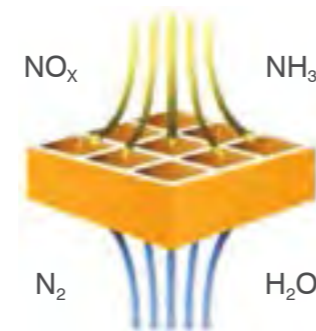

Basic reaction equation



For SCR technology, ammonia or urea is sprayed into the flue gas at 300~420°C, NO_x is reduced to yield nitrogen and water with effect of the catalyst.

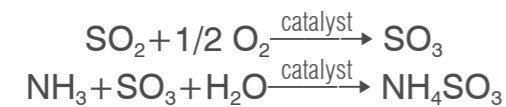

Side effect equation

Advantages of TUNA

TUNA has the professional team that has provided services for design, R&D, production and engineering of the flue gas purification projects of the thermal power plants, and TUNA has acquired specialized grade A qualification for environmental engineering (atmospheric pollution prevention and treatment engineering).

The main production equipments and production raw materials are imported from best suppliers, the high catalyst finished product qualified rate is guaranteed, the physical and chemical performances are excellent.

Rigorous testing procedures are followed and guaranteed by advanced testing equipments, such as plastometer, universal tester, ray diffraction analysis instrument, instrument area and hole volume analysis instrument and so on. In addition, TUNA has cooperated with the professional research institutes in China to guarantee strict performance for testing raw material, semi-finished products and finished product to ensure the catalyst quality.

TUNA provides overall solution for emission reduction behind the boiler, including design, engineering and manufacturing.

TUNA is one of drafters of the national standard on catalyst.



Types of SCR Catalyst

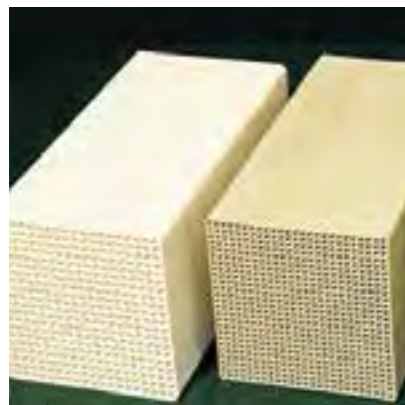

Honeycomb type

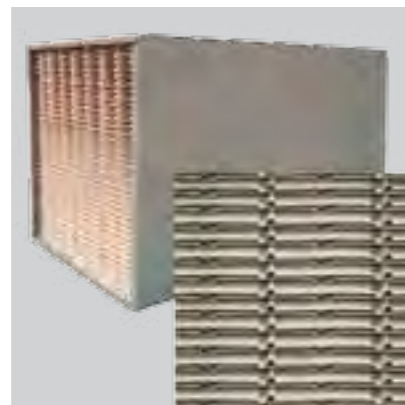

Plate type

Type	Honeycomb type catalyst	Plate type catalyst
Formation	Ceramic ware extrusion, formation is uniform, active constituent is distributed in overall way.	The stainless steel mesh is used as the carrier, the surface is coated with active constituent.
Characteristics	The specific surface area is large, activity is high, the required catalyst volume is small; the catalytic active substance is more by 50-70% than those of other types; in catalyst regeneration, the selective property is maintained.	Production line is simple but highly automated; flue gas go-through property is fine, blocking possibility is low; the integrated strength of the plate is high, is not easily broken, the activity is high.
Substrate	TiO ₂ , integrated extrusion	Stainless steel mesh
Catalyst activity	High	High
SO ₂ oxidation rate	Low	Low
Pressure loss	High	Low
Possibility of blocking	Moderate	Low
Module mass	Moderate	High
Heat resistance	Moderate	Moderate
Application scope	Mainly used for low dust, can also be used for high dust	Mainly used for high dust, can also be used for low dust

Honeycomb type catalyst

SCR catalyst takes Titanium dioxide (TiO₂) as the main carrier, adding active ingredient V (Vanadium), W (Tungsten) and Mo (Molybdenum), is a means of converting nitrogen oxides (NO_x) with the aid of a catalyst, into diatomic nitrogen (N₂), and water (H₂O), at operation flue gas temp. range 300-420°C using ammonia as the reducing agent.

Producing process

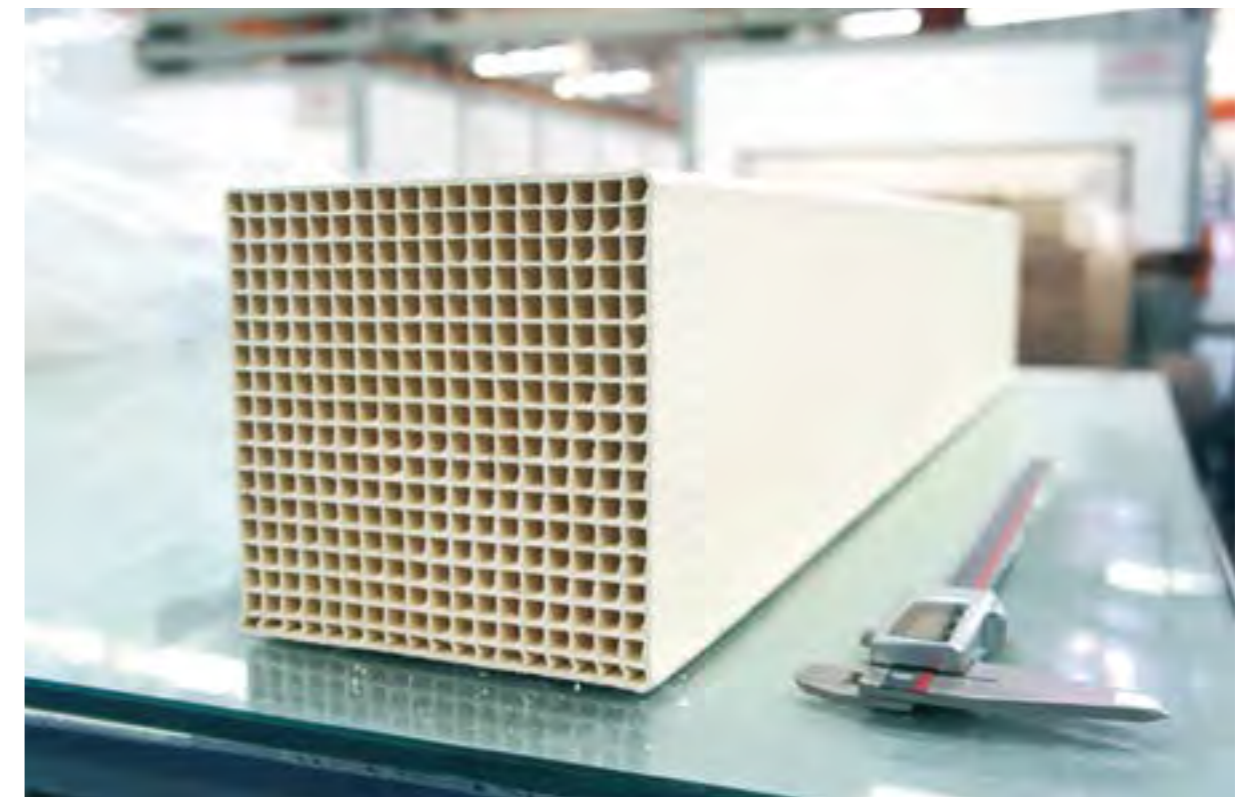
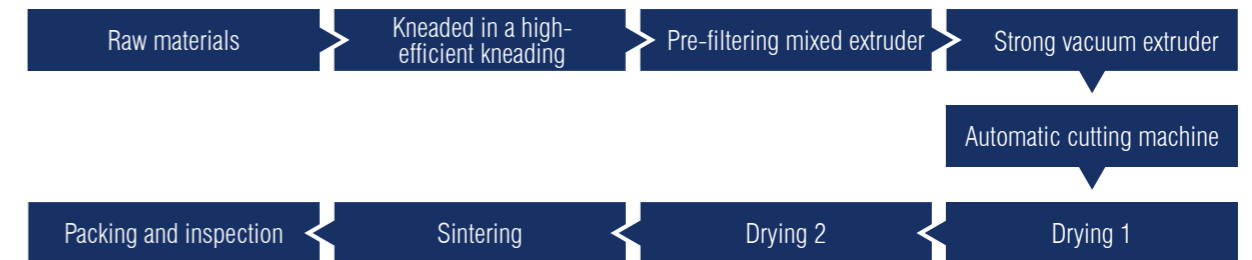

Honeycomb type lower cell catalyst

Number of cells	16×16	18×18	18×18	18×18	20×20	20×20	21×21	21×21	22×22	30×30
Outer diameter (mm)	150	150	150	150	150	150	150	150	150	150
Pitch (mm)	9.20	8.21	8.21	8.22	7.40	7.40	7.05	7.05	6.70	4.93
Aperture (mm)	8.00	7.11	7.21	7.32	6.40	6.50	6.10	6.15	5.80	4.13
Inner wall thickness (mm)	1.20	1.10	1.00	0.90	1.00	0.90	0.95	0.90	0.90	0.80
Outer wall thickness (mm)	2.00	1.70	1.60	1.50	1.50	1.45	1.50	1.45	1.50	1.40
Geometric specific surface area (m ² /m ³)	364	409	415	421	455	463	478	482	499	661
Porosity (%)	72.82	72.70	74.88	77.09	72.82	75.11	72.82	74.07	72.36	68.34

Application areas

Low cell catalyst is generally used in coal-fired units, cement kilns and other flue gas environments in which the dust content is 20-50 g/Nm³.

Performance index

- Overall molding processed. Homogeneous. Entirely covered by active ingredients.
- Micro specific surface area ≥ 50 m²/g, activity ≥ 42 m/h.
- Excellent DeNO_x performance at temperature range 300-420°C.
- Simple regeneration process.
- Strong adaptability, good resistance to poisoning.
- DeNO_x efficiency: $\geq 90\%$.
- SO₂/SO₃ conversion rate: $\leq 0.75\%$.
- Ammonia escape: ≤ 2.5 ppm.
- Mechanical life ≥ 10 years; chemical lifetime $\geq 24,000$ h.
- High mechanical strength, axial compressive strength ≥ 3.0 MPa, radial compressive strength ≥ 0.9 MPa.

Honeycomb type high cell catalyst

Number of cells	35×35	35×35	40×40	40×40	50×50	50×50	55×55	55×55	60×60	60×60
Outer diameter (mm)	150	150	150	150	150	150	150	150	150	150
Pitch (mm)	4.23	4.23	3.71	3.71	2.97	2.97	2.70	2.70	2.48	2.48
Aperture (mm)	3.48	3.53	3.11	3.21	2.47	2.52	2.25	2.30	2.03	2.08
Inner wall thickness (mm)	0.75	0.70	0.60	0.50	0.50	0.45	0.45	0.40	0.45	0.40
Outer wall thickness (mm)	1.35	1.30	1.20	1.00	1.00	0.95	0.95	0.90	0.95	0.90
Geometric specific surface area (m ² /m ³)	758	769	883	914	1098	1120	1210	1238	1297	1329
Porosity (%)	65.93	67.90	68.56	73.39	67.79	70.62	68.12	71.23	65.66	69.00

Application areas

High cell catalyst is usually arranged in the DeNO_x system with low dust content coal-fired boiler unit, natural gas distributed energy system, motor vehicle exhaust system, chemical/ glass kiln, marine diesel engine system, ferrous metallurgy.

Performance index

- Overall molding processed. Homogeneous. Entirely covered by active ingredients.
- Micro specific surface area ≥ 50 m²/g, activity ≥ 42 m/h.
- Good DeNO_x performance at a wider temperature range, 200-430°C.
- Simple regeneration process.
- Strong adaptability, good resistance to poisoning.
- High activity: NO_x removal rate $\geq 95\%$.
- Outstanding mechanical property: radial mechanical property ≥ 2.0 MPa, axial mechanical property ≥ 4.0 MPa.
- Long lifetime: catalyst lifetime $\geq 24,000$ h.
- Low ammonia escape rate: ammonia escape < 3 ppm.
- Low SO₂/SO₃ conversion rate: $\leq 0.75\%$.

Plate type SCR catalyst

The carrier for plate type catalyst is stainless steel mesh. On the surface of stainless steel mesh we coat active ingredients such as V (Vanadium), W (Tungsten) and Mo (Molybdenum), etc. At the temperature of 300-420°C, these active ingredients will convert the nitrogen oxides into nitrogen and water with the help of reducing agent such as ammonia or urea.

Technological process

preparing raw materials



compacting process

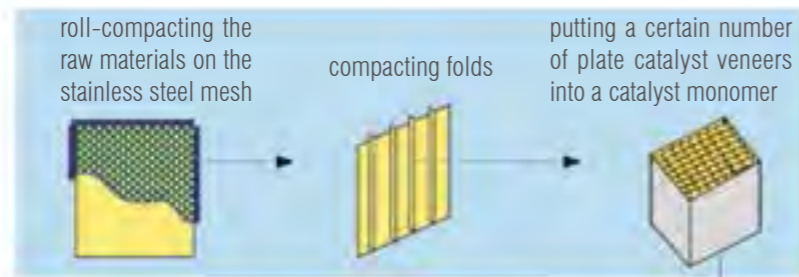

putting a certain number of plate catalyst cell boxes into a catalyst module

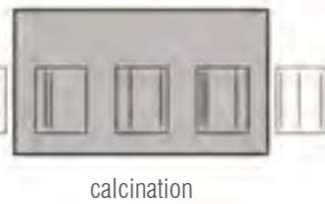

calcination

Generic parameters of plate type SCR catalyst

Specification	Pitch (mm)	Specific area (m ² /m ³)	Porosity (%)
TB-P824	7.1	284.2	87.8
TB-P288	7	288	87.6
TB-P300	6.7	299.5	87.1
TB-P307	6.5	307.2	86.8
TB-P315	6.3	314.8	86.5
TB-P330	6	330.1	85.8
TB-P345	5.7	345.4	85.1
TB-P357	5.5	356.9	84.6

Remark: pitch is determined by the operation condition

Application areas

Plate-type catalyst is generally used in coal-fired units, cement kilns and other flue gas environments in which the dust content is 20-100 g/Nm³.

Performance index

- Coating processed, using stainless steel as base material.
- Micro specific surface area ≥ 80 m²/g, activity ≥ 42 m/h.
- Excellent DeNO_x performance at temperature range 300-420°C.
- High activity: NO_x removal rate $\geq 90\%$.
- Long lifetime: catalyst lifetime $\geq 24,000$ h.
- Low ammonia escape rate: < 3 ppm.
- Low SO₂/SO₃ conversion rate: $\leq 0.75\%$.
- High mechanical performance.



Wide-temperature catalyst

Wide-temperature catalyst is a new type of SCR catalyst, highly active in a wide range of conditions. Operating temperature range is 200~420°C. In the aerobic condition of having reducing agent (NH₃), the NO_x in the flue gas is reduced into nitrogen and water with help of catalyst.

Application background

When the boiler of the power plant runs at low load, the flue gas temperature is lower than 300°C. Under such temperature condition, the ordinary high-temperature SCR catalyst activity is fairly lower, and the catalyst activity is not sufficient to boost sufficient NO_x and NH₃ for reaction, which will result in reducing denitration efficiency, the residual NH₃ will react with SO₂ to yield ammonium bisulfate, the catalyst cells or passages will be blocked, the subsequent catalyst will encounter dust deposition and wearing, or the air preheater will be blocked and so on.

Applicable measures

For the catalysts based on vanadium/titanium, the rare earth element is added to improve the catalyst activity at low temperature to widen the catalyst denitration temperature window. Within 200~420°C, the catalyst will have fairly higher activity to meet the denitration requirement, reduce yielding of ammonium bisulfate and realize denitration for the power plant under low-load operating conditions.

Performance parameters / features

- Denitration efficiency: > 98% at temperature range of 200-420°C.
- Specific surface area: 70 ± 5 (m²/g).
- Compressive strength: axial compressive strength ≥ 2.5 MPa, radial compressive strength ≥ 0.8 MPa.
- Wider active window allows it operating at 200-420°C.
- Strong sulfur tolerance effectively reduces the formation of ABS.
- Low attenuation of active ingredients, longer lifetime.
- Operation and maintenance friendly.

Dioxins catalyst

Dioxins catalyst is the active catalyst that can decompose dioxins to produce harmless water vapor, carbon dioxide and hydrogen chloride.

Technology background

The company closely cooperated with the Environment School of Tsinghua University to develop the new type dioxin removal catalyst. The dioxin removal catalyst is made as honeycomb type, assembled with the steel frame and is distributed in the reactor. The dioxin removal efficiency can achieve 99%, and the applicable temperature range is 200~420 °C.

Performance parameters

- De-dioxin efficiency: >98%, at temperature range of 200-420°C.
- Specific surface area: ≥ 70 m²/g.
- Compressive strength: axial compressive strength ≥ 3.5 MPa, radial compressive strength ≥ 1.2 MPa.

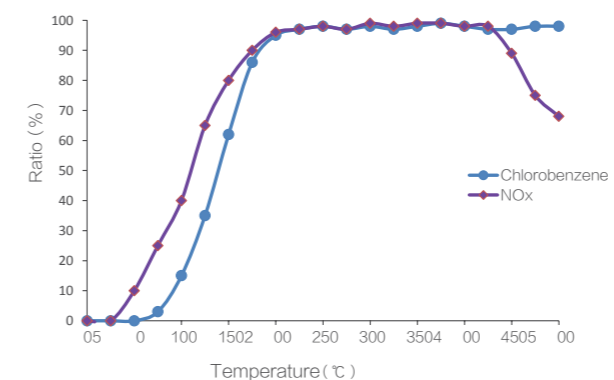

Operating mechanism

Catalytic dioxin destruction is a terminal treatment, by the catalyst's active adsorption and oxidation. While heating, the catalytic oxidation will happen. Ultimately, the dioxin molecules are transmuted into carbon dioxide, water and hydrochloric acid and other non-polluting small molecule products.



In addition, it also has DeNO_x function, which is solution of synergistic control of multi pollutants.

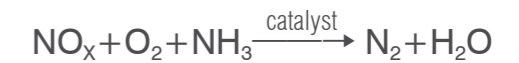

Product features

- Catalytic decomposition of dioxins, without secondary treatment.
- Wider active window allows it operating at 200-420°C.
- DeNO_x function, by using NH₃ as reducer.
- High decomposition performance and long service life.
- Renewable, more economic than activated carbon adsorption process.
- Modified based on existing equipment.



Testing Lab and Equipments



Instrument analysis lab



Activity analysis lab



X-ray fluorescence spectrometer (Japan)



Pe8000 (USA)

General Features of TUNA Catalyst

Excellent adaptation to temperature—200-420°C.

Highly active—removal rate of NO_x is up to 90%.

Long service life—24,000 hours.

Good selectivity—increasing utilization rate of reducing agent and lowering operation cost.

Excellent mechanical property—stronger, higher reliability in abrasion resistance and thermostability.

Good resistance to toxicants—excellent corrosion resistance to various alkali, alkaline ash and arsenic.

Small pressure loss and ammonia escape amount—less than 3 ppm.

Conversion rate of SO₂/SO₃ is less than 0.75%.



Physical and chemical analysis lab

ESPs & GGH

TUNA's ESP division is specialized in design, engineering, manufacturing and installation of all types of ESPs and Bag Filter. TUNA had made major achievements in Wet-ESP which enable TUNA to provide solutions for ultra-low flue gas emission (PM less than $5\text{mg}/\text{Nm}^3$).

Product range

TUNA supplies a complete set of ESP/Wet-ESP equipment, while the following key components are also supplied separately:

- ① Discharging electrode
- ② Collecting electrode module
- ③ Collecting plate
- ④ H-type finned tube heat exchanger
- ⑤ Fluoroplastic pipe heat exchanger



Discharging electrode

The rigid type pin punctured discharging electrode is used for corona discharge, consists of the rigid round pipe and discharging pin which is commonly made of 316L, 2205, titanium alloy etc.



Discharging pin with smooth surface.

Flat connection piece at both sides of the discharging electrode.



Collecting electrode module

Several FRP collecting pipes are arranged into honeycomb shape, having smooth and flat surface, external fixed with flange framework.

Features:

- Strong anti-corrosion performance, including corrosion of diluted acids, alkali and salt media. Long service life.
- Fine flame retardation property, oxygen index ≥ 32 .
- Fine conductivity, surface resistance $\leq 50\Omega$.



Collecting plate

During the operation of electrostatic precipitator, a high voltage electric field is formed between negative and positive poles, and the negative pole produces corona discharge. Negative charge moves to the positive plate under the action of the electric field force after the combination with dust. The dust is collected on the surface of the positive plate, then enters the hopper and separates from the flue gas after cleaning. The positive plate is usually integrally rolled by the cold rolling plate. The common material for positive plate is 316L & 2205.

Features:

- Integrally rolled, without welding
- Flat and smooth surface, easy for dust removal and without scale formation
- Uniform water film, without dead zone

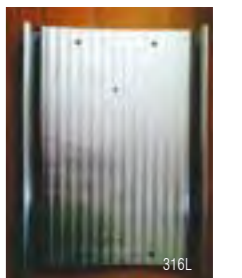

H type finned tube heat exchanger

H type finned tube heat exchanger is mainly used for reducing the exhaust flue gas temperature from boiler, recovering and utilizing the residual heat to achieve such energy-saving and consumption reducing purposes as increasing the generating efficiency, improving the ESP efficiency, reducing the water consumption of FGD. The product can also be used for other high energy consumption fields like metallurgy, chemical industry. It is served as the flue gas cooler and flue gas reheater.



Product characteristics

- With the special welding equipment, H type fins are solidly connected to the base tube, and the tube surface will not be damaged.
- H type finned tube is used as the heat exchange elements, having high heat transfer efficiency, less ash deposition, compact structure, to ensure a good residual heat recovery effect.
- With line arrangement, the space is divided into several small sections to achieve air current sharing, the wear life can be increased by 3-4 times.
- Sootblowing effect is fairly better, less pressure drop.
- The welded part of elbow is at both sides of the flue to avoid the wearing and leakage at the welded position.
- The base tube with regular length is used. For the whole base tube, there is only welding seam at the elbow to avoid the leakage caused by the welding seam.



Fluoroplastic tube heat exchanger

Fluoroplastic tube heat exchanger takes the small-diameter fluoroplastic hose made of PTFE as the heat exchanging tube.

Performance features

- Extremely strong anti-corrosion performance.
- It has stable chemical performance, and can be applied in most of poor operating environment.
- Fine scale formation preventing performance.
- Smooth surface of both internal and external, minimum surface tension among all solid materials. Non-adhere to any substance.
- Low resistance due to minimal friction coefficient (0.04).
- Fine temperature-resistance (-190~260°C.) and pressure resistance (-1.0 MPa, with thickness of 1mm).
- Strong thermal stability, hot creep performance and excellent ageing resistance, and durable, service life >20 years.



TUNA developed electric system for ESP/Wet-ESP, FGD, DeNOx, etc. widely used in many power plants, steel plants and cement plants, especially the High-Frequency Transformer Rectifier, over-frequency Transformer Rectifier for ESP/Wet-ESP. All products are having CCC Certificate .

Product range

- ① TEPH-I Series High-frequency T/R
- ② TEPP-I Series Pulse T/R
- ③ KYN28-12 HV Series
- ④ GGD Switchgear
- ⑤ GCK LV Draw-out Type Switchgear
- ⑥ GCS LV Draw-out Type Switchgear
- ⑦ MNS LV Draw-out Type Switchgear



Structure diagram

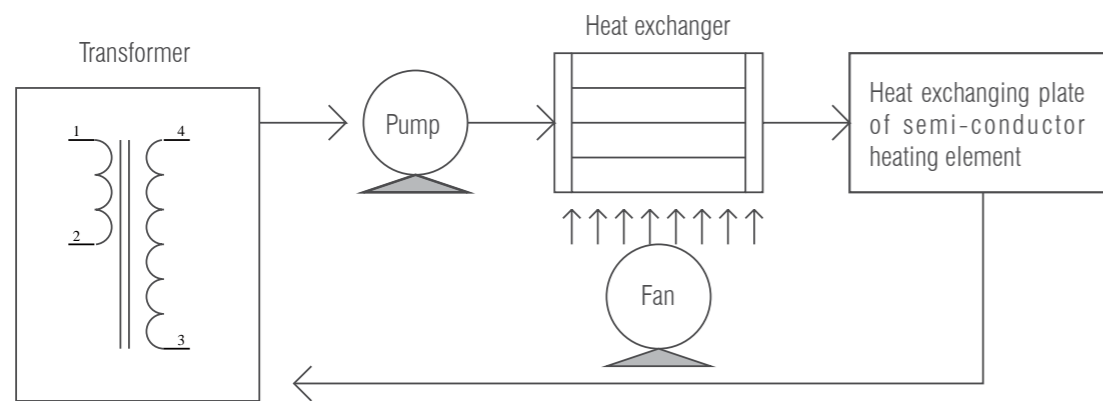

Electric principle

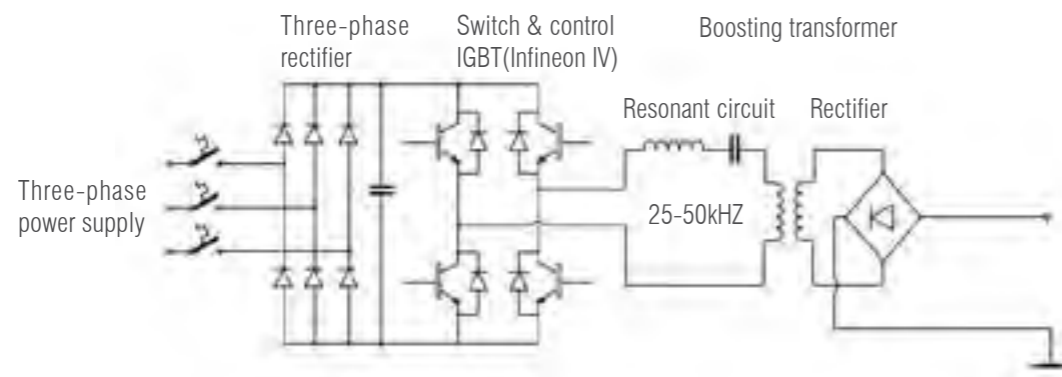

Benefits of TEPH-I

- TEPH-I uses the popular elements and devices in the industry to guarantee the running reliability.
- With higher output efficiency, the running cost of T/R during the whole service life is lower.
- With advanced DSP-based high-speed controller, TEPH-I has faster response speed, greater sampling precision and more stable control time sequence.
- With the friendly host computer control interface and fine after-sale technical support, the operator can control and know the running parameters in real time.

Optimized control

More precise test

- Double test for TEPH software and hardware
- TEPH signal test cycle: $25\mu\text{s}$
- SCR signal test cycle $>10\text{ms}$
- Maximum difference of the test precision: 400 times

Faster shut-off

- TEPH spark shut-off time is about $25\mu\text{s}$
- SCR spark shut-off time is $>10\text{ms}$
- TEPH control shut-off is faster

Faster recovery

- The recovery time after TEPH spark is about 10ms
- The recovery time after SCR spark is $>80-100\text{ms}$
- The recover speed is faster by more than 10 times in maximum degree



Higher voltage for use

- TTEPH ripple coefficient $<5\%$
- SCR ripple coefficient: 20-30%
- Peak voltage is basically equal to the average voltage

SCR power frequency T/R

TEPH high-frequency T/R

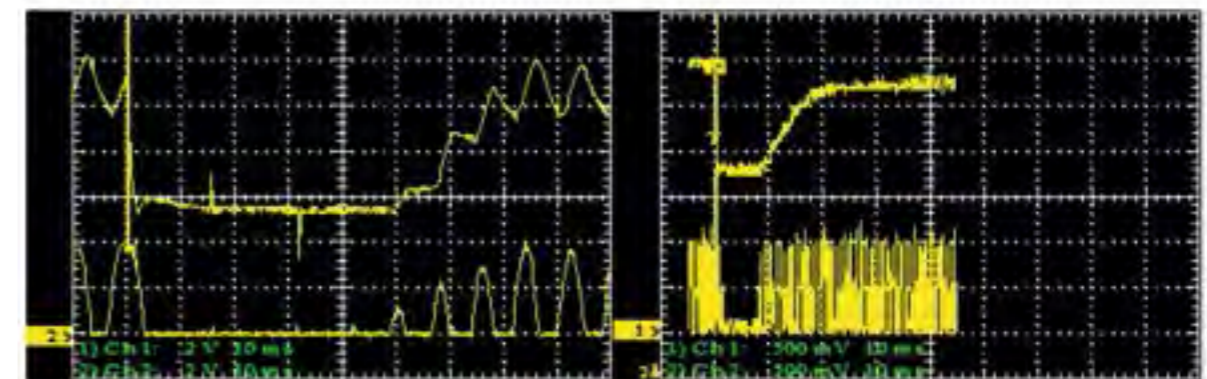

TEPP-I series of HV impulse T/R for ESP is independently researched and developed by the Electric Division of TUNA Corporation. With instantaneous and high-efficiency power input, the ash particle charging property is enlarged, having better performance in case of high ash resistivity, ESP efficiency is improved.

Product technical characteristics

- **High impulse voltage:** TEPP-I can provide surprising instantaneous power output capacity (>10MW) due to UHP IGBT module and impulse transformer. If combined with the HF T/R, the system will achieve an extra-high voltage (up to 140KV) instantaneously.
- **High ESP efficiency:** With instantaneous and high power input, within short time, the ESP voltage will be increased to a level beyond the capacity of HF T/R or conventional T/R. Thus, the ash particle charging property is greatly increased, so is the migration velocity.
- **Flexible use:** The impulse power supply is used together with the HF T/R or Conventional T/R, suitable for ESP R&M cases. Without changing other existing systems, the ESP efficiency can be improved through installing additional impulse power supply to satisfy the new emission standard.
- **Cooling mode:** Compared with the natural cooling proposed by other suppliers, TUNA's impulse power supply uses the unique heat exchanger cooling mode, to achieve a greater cooling effect.
- **High efficiency:** Such impulse power supply uses the unique electromagnetic energy recovery technology, and thus the energy conversion efficiency of the system is greatly improved.

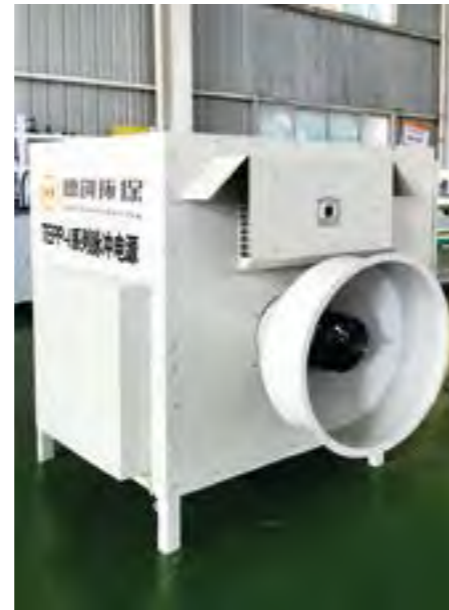

Product basic parameters (TEPP-I)

Input	Three-phase, AC380V 30KW 50/60 Hz, ±5%
Output	150A, 70KV, 150HZ
Power supply efficiency	≥90%
IP	IP65
Service life	10 years

KYN28-12 HV series of products



GCK LV draw-out type switchgear



GGD switchgear



GCS LV draw-out type switchgear MNS LV draw-out type switchgear



Project Reference



Project Installed Capacity

Project Type	Wet-ESP Project		FGD System Project		DeNOx System Project	
	Category	No. of Units	MW	No. of Units	MW	No. of Units
1000MW	9	9,000	-	-	-	-
600MW	18	11,140	4	2,500	3	1,800
300MW	41	12,930	7	2,250	4	1,320
<300MW	39	2,168	19	1,935	33	2,340
Total Installed Capacity	107 Units	35,238MW	30 Units	6,685MW	40 Units	5,460MW

Cumulative Installed Capacity-Products

Products	Honeycomb Type SCR Catalyst		Plate Type SCR Catalyst		FGD Products	
	Category	No. of Units	MW	No. of Units	MW	No. of Units
1000MW	6	6,000	5	5,120	60	60,200
600MW	57	33,240	9	6,895	392	245,858
300MW	106	31,292	11	6,480	577	201,034
<300MW	80	7,158	18	2,043	2,031	100,000 +
Total Installed Capacity	249 Units	77,690MW	30 Units	6,685MW	3,060 Units	600,000MW +

Recent Reference-Products

No.	Project Name	Capacity	Product
1	Huadian Ningxia Ningwu Power Plant Unit 3&4	2×1,060MW	Plate type SCR Catalyst
2	Guangdong Huizhou Pinghai Power Plant Unit 1&2	2×1,000MW	Plate type SCR Catalyst
3	Huadian Zhouxian Power Plant	1×1,000MW	Plate type SCR Catalyst
4	Guodian Zhejiang Beilun No.3 Power Plant Unit 6&7	2×1,000MW	Honeycomb type SCR Catalyst
5	Zhejiang Zheneng Liuheng Power Plant Unit 2	1×1,000MW	Honeycomb type SCR Catalyst
6	Huaneng Qinbei Power Plant Unit 5&6	2×1,000MW	Honeycomb type SCR Catalyst
7	Wanneng Tongling Power Plant	1×1,000MW	Honeycomb type SCR Catalyst
8	Xinjiang Nongliushi Coal-fire Power Plant	2×1,100MW	FGD Slurry Piping
9	Huadian Laizhou Power Plant Ph-I	2×1,000MW	FGD Slurry Piping
10	CHINA RES POWER Hezhou Power Plant Ph-I	2×1,000MW	FGD Slurry Piping
11	Guodian Laizhou Power Plant PH-II	2×1,000MW	Mist Eliminator
12	An'Hui Huadian Wuhu Power Plant	2×660MW	Mist Eliminator
13	Shenhua Fujian Luoyuan Power Plant	2×1,000MW	Rubber-lined Pipes
14	Zheneng Taizhou Power Plant	2×1,000MW	Vacuum Belt Dehydrator
15	Zheneng Jiahua Power Plant	2×1,000MW	Damper

Overseas Project Reference-Products

No.	Country	Project	Capacity	Date	Product
1	Laos	Hongsa TPP	3×626MW	2012.5	Damper
2	Pakistan	Qasim Coal-fired Power Plant	2×660MW	2016.1	Spray system
3	Turkey	EREN Supercritical Coal-fired Power Plant	2×600MW	2012.4	Demister, Damper
4	Vietnam	Haiphong Power Plant	2×300MW	2011.9	Damper, FRP Spray pipes, Alloy parts
5	Vietnam	Uong Bi TPP II Expansion Project	1×330MW	2008.1	FRP Spray pipes, Damper, Demister
6	Philippines	PASAR Extension Project	1×200MW	2014.3	Damper
7	Kyrgyzstan	Bishkek Power Plant	2×150MW	2016.1	Spray system, Rubber-lined pipe
8	Indonesia	Medan Industrial Park Coal-fired Power Plant	2×150MW	2016.3	Spray system
9	Indonesia	Seawater FGD of Bali Power Plant	3×142MW	2013.7	FRP Spray pipes
10	Sudan	Khartoum North Power Plant Phase III	2×100MW	2007.1	Damper
11	Malaysia	Negri Sembilan Cement Industries Sdn. Bhd	5000TPD	2017.3	Vacuum belt dehydrator
12	India	BHEL NTPC Dadri FGD Project	2×490MW	2018.7	Limestone Grinding System
13	India	L&T NTPC Khargone FGD Project	2×660MW	2019.4	Gypsum Dewatering System
14	India	L&T NTPC Khargone FGD Project	2×660MW	2019.4	Gypsum Dewatering System
15	India	L&T NTPC Lara FGD Project	2×800MW	2019.4	Gypsum Dewatering System
16	India	L&T NTPC Darlipalli FGD Project	2×800MW	2019.4	Gypsum Dewatering System

